

SINGER
400W106 THRU 400W110

USE ONLY **SINGER*** OILS and LUBRICANTS

They insure freedom from lubricating trouble and give longer life to sewing equipment

*The following are the correct lubricants for the
241, 400w and 410w Machines:*

TYPE A — MANUFACTURING MACHINE OIL, LIGHT GRADE

When a stainless oil is desired, use:

TYPE C — MANUFACTURING MACHINE OIL, STAINLESS, LIGHT GRADE

OTHER **SINGER** LUBRICANTS

TYPE E — STAINLESS THREAD LUBRICANT

For lubricating the needle thread of sewing machines for stitching fabrics or leather where a stainless thread lubricant is required.

TYPE F — MOTOR OIL

For oil lubricated motors and plain bearings in power tables and transmitters.

NOTE: All of the above oils are available in 1 quart, 1 gallon and 5 gallon cans or in 55 gallon drums.

BALL BEARING LUBRICANT

This pure grease is specially designed for the lubrication of ball bearings and ball thrust bearings of motors and electric transmitters, ball bearing hangers of power tables, etc. Furnished in 1 lb. and 4 lb. tins.

Copyright, U. S. A.,
1914, 1915, 1922, 1926, 1935, 1940, 1941, 1944, 1946, 1947 and 1948,
by The Singer Manufacturing Company
All Rights Reserved for all Countries

2967w

INSTRUCTIONS

FOR USING AND ADJUSTING

SINGER*

SEWING MACHINES

400W106, 400W107, 400W108,
400W109 AND 400W110

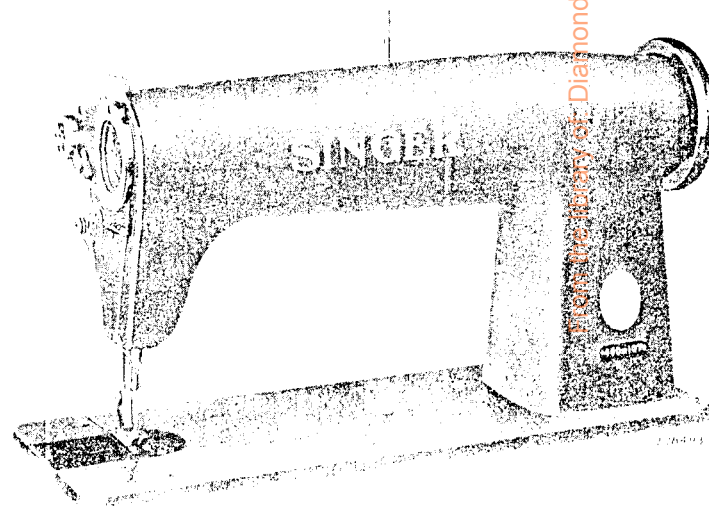

SINGLE NEEDLE

LOCK STITCH

* Reg. U. S. Pat. Off. by

THE SINGER MANUFACTURING CO.

TO ALL WHOM IT MAY CONCERN:

The improper placing or renewal of the Trade-Mark "SINGER" or any other of the Trade-Marks of The Singer Manufacturing Company (all of which are duly Registered Trade-Marks) on any machine that has been repaired, rebuilt, reconditioned, or altered in any way whatsoever outside a SINGER factory or an authorized SINGER agency is forbidden.

THE IMPORTANCE OF USING **SINGER*** PARTS AND NEEDLES IN **SINGER** MACHINES

The successful operation of SINGER machines can only be assured if SINGER parts and needles are used. Supplies are available at all SINGER Shops for the Manufacturing Trade, and mail orders will receive prompt attention.

SINGER Needles should be used
in SINGER Machines.
These Needles and their Containers
are marked with the
Company's Trade-Mark "SIMANCO.*" 1

Needles in Containers marked
"FOR SINGER MACHINES"
are NOT **SINGER** made needles. 2

DESCRIPTION

Machine 400w106 is a long arm, high speed, single needle, lock stitch machine equipped with a double rotary thread take-up. It has a belt-driven, automatically lubricated rotary sewing hook on a horizontal axis. The drop feed can be adjusted by means of a one-hand stitch regulator to make from 5-1/2 to 30 stitches per inch even while the machine is in operation. The needle bar stroke is 1-13/64 inches and the maximum presser bar lift is 5/16 inch. The machine is particularly advantageous for stitching medium and medium-heavy fabrics where frequent change in stitch length is required.

Machine 400w107 is a long arm, high speed, single needle, lock stitch machine equipped with a double rotary thread take-up. It has a belt-driven, automatically lubricated rotary sewing hook on a horizontal axis. The drop feed is adjustable for stitches from 5-1/2 to 30 per inch. The needle bar stroke is 1-9/64 inch and the maximum presser bar lift is 9/32 inch. The machine is used for stitching light and medium weight fabrics.

Machine 400w108 is the same as Machine 400w107 except that it has a 1-13/64 inch needle bar stroke and 5/16 inch presser bar lift, and is adapted for stitching medium heavy weight fabrics.

Machine 400w109 is the same as Machine 400w107 except that it has a 1-7/16 inch needle bar stroke and 3/8 inch presser bar lift, for stitching heavy and extra heavy weight fabrics.

Machine 400w110 is equipped for shoulder joining on shirts; otherwise it is similar to Machine 400w108. This machine is a long arm variety of the 400w25.

SPEED

The speed recommended for these machines is 5000 P.M. It is advisable to run a new machine slower than the maximum speed for the first few minutes to allow time for the oil to reach the moving parts. The balance wheel turns over from the operator.

SETTING UP

The drip pan should be attached with its right end even with the right end of the cut-out and low enough in the cut-out to avoid interference with the knee lifter rod A, Fig. 2. Fig. 2 shows the correct location of the knee lifter. The knee lifter bracket should be assembled so that the lifter rod A does not strike the drip pan. The screw slots in the bracket provide the necessary adjustment. The stop stud B, Fig. 2 should be set to stop the action of the knee lifter as soon as the presser foot is raised enough to trip the hand lifter.

CAUTION: Do not start a machine, not even to test the speed, until it has been thoroughly oiled as instructed on page 4.

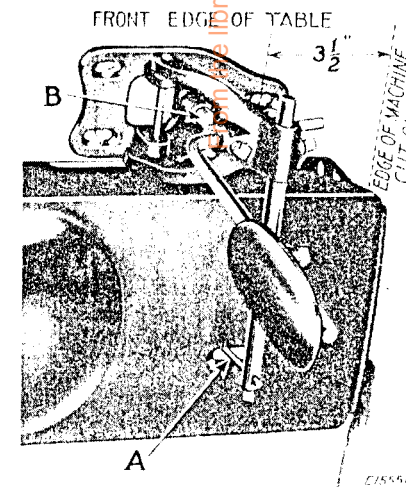

Fig. 2. Position of Knee Lifter Under Table

OILING THE MACHINE

Use "TYPE A" or "TYPE C" OIL, sold only by Singer Sewing Machine Company for 241, 400w and 410w Machines. See inside front cover for description of these oils.

A reservoir in the bed of the machine supplies oil to the sewing hook race and to the bearings and eccentrics on the hook driving shaft (except the rear ball bearing). The other lubrication points are reached by seven oil holes, marked with red. See "X-Ray" view of machine on pages 16 and 17.

BEFORE STARTING THE MACHINE, fill the oil reservoir (through the oil gauge hole) to the top mark on the oil gauge **E**, Fig. 3.

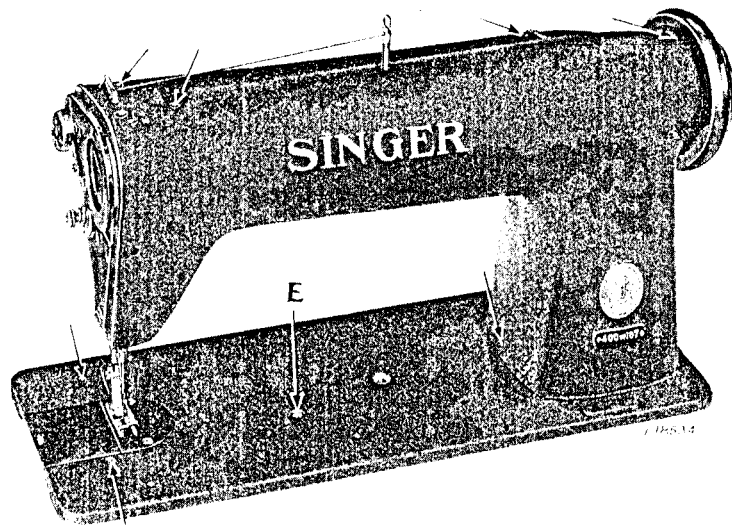

Fig. 3. Showing the Eight Oiling Points on the Machine

While it may not be necessary to add oil to the reservoir every day, the oil level must be checked daily. For short runs, the oil level should be maintained slightly above the lower mark on the oil gauge **E**. For long or continuous runs, the oil level should be maintained at the high mark on the oil gauge. Never allow the oil level to drop below the lower mark on the oil gauge.

ONCE A DAY, turn the balance wheel until the needle is all the way up, and place **A FEW DROPS** of oil in each of the seven oil holes indicated by arrows in Fig. 3.

NEEDLES

Needles for Machines 400w106 and 400w107 are of **Class and Variety 88x1**, which are made in sizes 7, 8, 9, 10, 11, 12, 13, 14, 16, 17, 18, 19 and 21.

Needles for Machines 400w108 and 400w109 are of **Class and Variety 135x5**, which are made in sizes 8, 9, 10, 11, 12, 13, 14, 16, 18, 19 and 21.

Needles for Machines 400w110 are of **Class and Variety 135x7**, which are made in sizes 7, 8, 9, 10, 11, 12, 14, 16, 18, 20 and 21.

The above needles regularly have nickel finish but can be supplied with chromium finish if ordered.

The size of the needle to be used should be determined by the size of the thread, which must pass freely through the eye of the needle. Rough or uneven thread, or thread which passes with difficulty through the eye of the needle, will interfere with the successful use of the machine.

Orders for needles must specify the **Quantity** required, the **Size** number, also the **Class and Variety** numbers separated by an x.

The following is an example of an intelligible order:

"50 No. 16, 88x1 Needles."

The best stitching results will be obtained by using the needles furnished by the Singer Sewing Machine Company.

THREAD

Left twist thread should be used in the needle. Either right or left twist thread can be used in the bobbin.

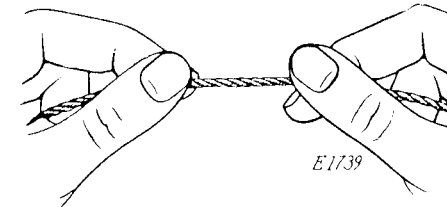

Fig. 4. How to Determine the Twist

Hold the thread as shown above. Turn the thread over toward you between the thumb and forefinger of the right hand; if left twist the strands will wind tighter; if right twist, the strands will unwind.

TO REMOVE THE BOBBIN

Turn the balance wheel over from you until the needle moves up to its highest position. Draw back the slide in the bed of the machine. Reach

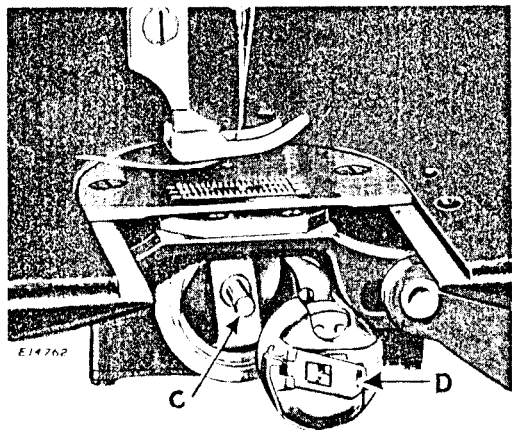

Fig. 5. Removing the Bobbin

under the table and open the bobbin case latch **D**, Fig. 5 and, by means of this latch, remove the bobbin case from the sewing hook.

While the latch remains open, the bobbin will be retained in the bobbin case. Release the latch, turn the open end of the bobbin case downward and the bobbin will drop out.

TO WIND THE BOBBIN

(See Fig. 6)

Fasten the bobbin winder to the table with its driving pulley in front of the machine belt, so that the pulley will drop away from the belt when sufficient thread has been wound upon the bobbin.

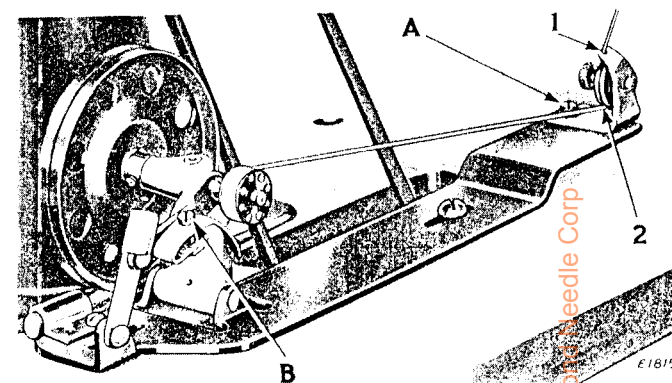

Fig. 6. Winding the Bobbin

Place the bobbin on the bobbin winder spindle and push it on as far as it will go.

Pass the thread down through the thread guide **1** in the tension bracket, around the back of, and between, the tension discs **2**. Then wind the end of the thread around the bobbin a few times in the direction shown in Fig. 6, push the bobbin winder pulley over against the machine belt and start the machine.

When sufficient thread has been wound upon the bobbin, the bobbin winder will stop automatically.

If the thread does not wind evenly on the bobbin, loosen the screw **A** in the tension bracket and move the bracket to the right or left as may be required, then tighten the screw.

The amount of thread wound on the bobbin is regulated by the screw **B**. To wind more thread on the bobbin, turn the screw **B** inwardly. To wind less thread on the bobbin, turn this screw outwardly.

Bobbins can be wound while the machine is stitching.

When winding a bobbin with fine thread, a light tension should be used.

TO THREAD THE BOBBIN CASE

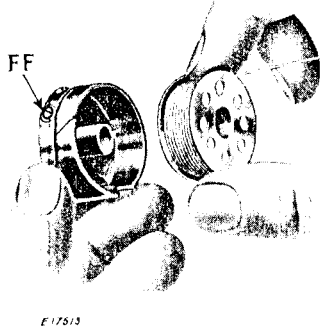

Fig. 7

Hold the bobbin between the thumb and forefinger of the right hand, as shown in Fig. 7, the thread drawing on the top from the left toward the right.

With the left hand hold the bobbin case as shown in Fig. 7, the slot in the edge being near the top, and place the bobbin into it.

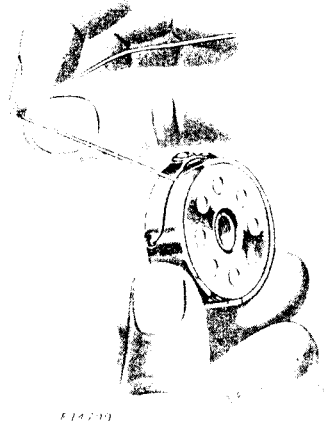

Fig. 8

Then pull the thread into the slot in the edge of the bobbin case as shown in Fig. 8; draw the thread under the tension spring and into the delivery eye at the end of the tension spring. See Fig. 9.

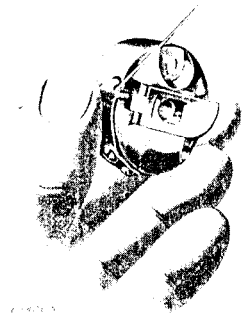

Fig. 9

TO REPLACE THE BOBBIN CASE

After threading, take the bobbin case by the latch and place the bobbin case on the center stud C, Fig. 5 of the bobbin case holder; release

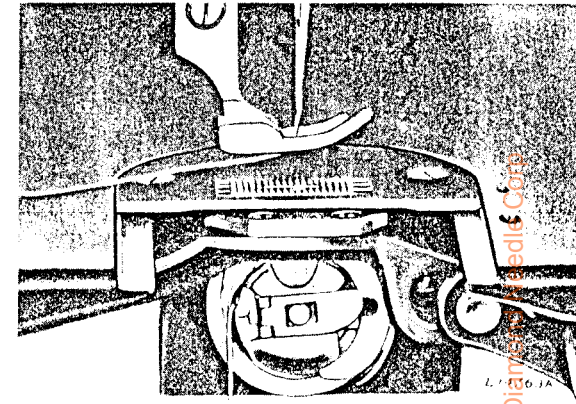

Fig. 10. Bobbin Case Threaded and Replaced

the latch and press the bobbin case back until the latch catches the groove near the end of the stud. See Fig. 10. Allow about two inches of thread to hang free, and replace the slide in the bed of the machine.

TO SET THE NEEDLE

Turn the balance wheel over from you until the needle bar moves up to its highest point; loosen the screw at the lower end of the needle bar and put the needle up into the bar or clamp as far as it will go, with the long groove of the needle toward the left and the eye of the needle directly in line with the arm of the machine, then tighten the screw.

UPPER THREADING

(See Fig. 11)

As soon as an operator has become accustomed to threading this machine, the thread can be passed from the thread retainer at the top, down to the needle with a single continuous motion.

Turn the balance wheel over from you until the two pins P in the rotary take-up are directly toward the front, as shown in Fig. 11 inset.

Pass the thread from the unwinder through the top hole 1 in the pin on top of the machine, then around and through the lower hole 2 in the pin, thence through the three holes 3, 4 and 5 in the thread retainer. Hold the thread with the right hand near the thread retainer while passing the thread, with the left hand, downward into the inner slot 6 (guiding it into the hole 7) and on down in front of the tension discs 8, around between the tension discs into the take-up spring 9 and under the thread pull-off 10 then over through the slot 11, allowing the thread to fall in place over the take-up discs. Now release the thread with the right hand, and pass it down through the guides (12, 13 and 14[†]), then from left to right through the eye of the needle 15. Leave about three inches of thread with which to commence sewing.

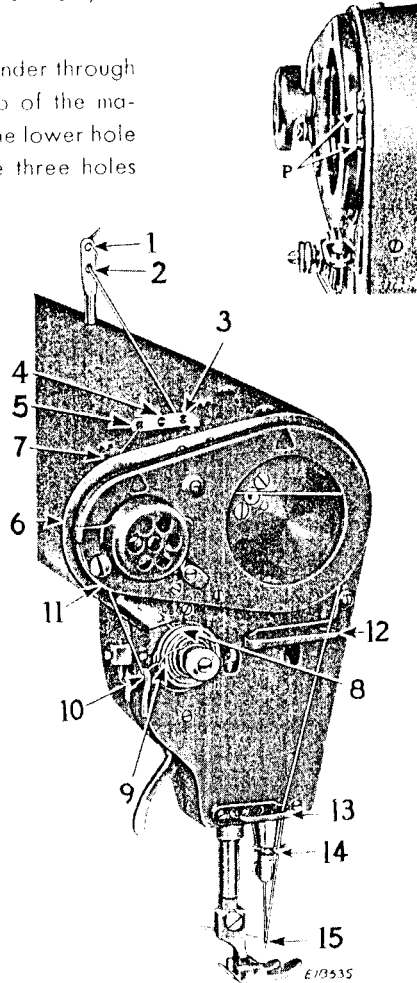

Fig. 11. Threading the Needle

[†]NOTE: The thread guide 14 should be turned on the needle bar bushing so that the thread leads in a straight line from the guide 13 to the needle eye. The thread retainer 5 should be turned so that the thread leads through the center of hole 7.

TO PREPARE FOR SEWING

With the left hand hold the end of the needle thread, leaving it slack from the hand to the needle, turn the balance wheel over from you until

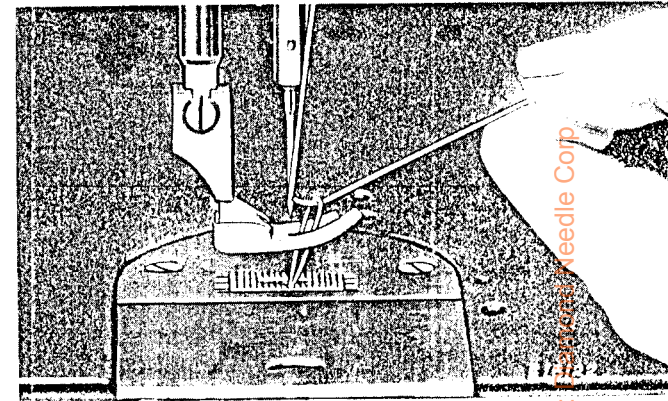

Fig. 12. Drawing Up the Bobbin Thread

the needle moves down and up again to its highest point, thus catching the bobbin thread; draw up the needle thread and the bobbin thread will come up with it through the hole in the throat plate. See Fig. 12. Lay both threads back under the presser foot.

TO COMMENCE SEWING

Place the material beneath the presser foot, lower the presser and commence to sew, turning the balance wheel over from you.

TO REMOVE THE WORK

Stop the machine when the needle bar has just started to descend or with the two pins P, Fig. 11 in the rotary take-up directly toward the front. In this position the take-up will not unthread the needle when the machine is started. Raise the presser foot, draw the work back and cut the threads close to the work.

INSTRUCTIONS FOR USE OF THREAD SEVERING DEVICE

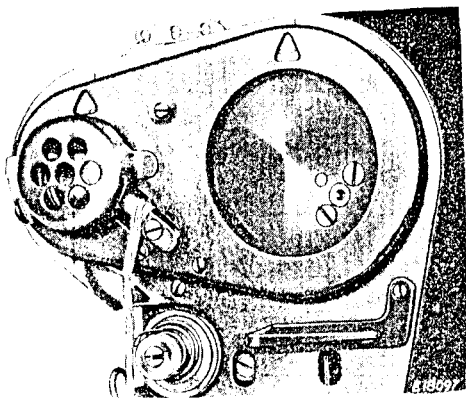

Fig. 13

Operator grasps loops of thread and severs them across sharpened edge of Thread Severing Finger, as shown in Fig. 14.

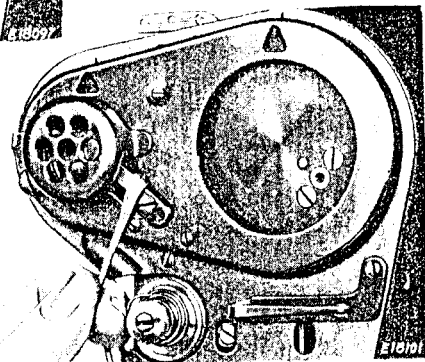

Fig. 14

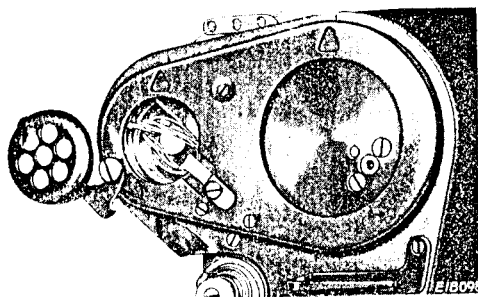

Fig. 15

When thread breaks at operating speeds, loops of thread from small take-up disc may accumulate on Thread Severing Finger, as shown in Fig. 13.

At low speed, loops of thread may remain over the tapered pin of the small take-up disc. When this occurs, the operator opens the guard, as shown in Fig. 15, removes the loop from the tapered pin and severs them as described above. Usually the machine will clear itself when it is again started.

TENSIONS

For ordinary stitching, the needle and bobbin threads should be locked in the center of the thickness of the material, thus:



Fig. 16. Perfect Stitch

If the tension on the needle thread is too tight, or if that on the bobbin thread is too loose, the needle thread will lie straight along the upper surface of the material, thus:



Fig. 17. Tight Needle Thread Tension

If the tension on the bobbin thread is too tight, or if that on the needle thread is too loose, the bobbin thread will lie straight along the under side of the material, thus:



Fig. 18. Loose Needle Thread Tension

TO REGULATE THE TENSIONS

THE TENSION ON THE NEEDLE THREAD SHOULD BE REGULATED ONLY WHEN THE PRESSER FOOT IS DOWN. Having lowered the presser foot, turn the small thumb nut at the front of the tension discs over to the right to increase the tension. To decrease the tension, turn this thumb nut over to the left.

The tension on the bobbin thread is regulated by the large screw FF, Fig. 7 in the tension spring on the outside of the bobbin case. To increase the tension, turn this screw over to the right. To decrease the tension, turn this screw over to the left.

When the tension on the bobbin thread has been once properly adjusted, it is seldom necessary to change it, as a correct stitch can usually be obtained by varying the tension on the needle thread.

TO REGULATE THE PRESSURE ON THE MATERIAL

The pressure of the presser foot on the material is regulated by the screw **F**, **Fig. 19** in the top of the arm. Turn this screw to the right to increase the pressure or to the left to decrease the pressure.

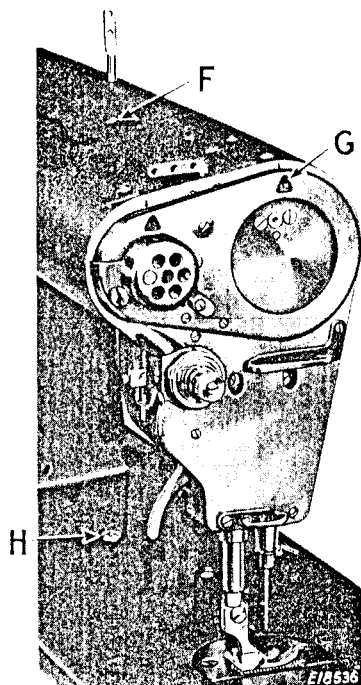

Fig. 19. Stitch Regulator and Indicator
on Machines 400w107, 400w108, 400w109 and 400w110

TO REGULATE THE LENGTH OF STITCH (Except Machine 400w106)

To change the length of stitch, press down the stud **H**, **Fig. 19** in the bed of the machine and at the same time turn the balance wheel slowly until the stud enters a notch in the adjustable feed eccentric cam. Still holding the stud, turn the balance wheel a part of a revolution until the number indicating approximately the number of stitches per inch desired appears in the hole **G** over the large take-up disc, then release the stud.

DO NOT TOUCH THE STUD "H" WHILE THE MACHINE IS RUNNING.

TO REGULATE THE LENGTH OF STITCH (Machine 400w106)

The machine can be adjusted to make approximately 5-1/2 to 30 stitches per inch as indicated by the numbered graduations on the stitch indicator plate. The length of stitch can be changed even while the machine is in operation.

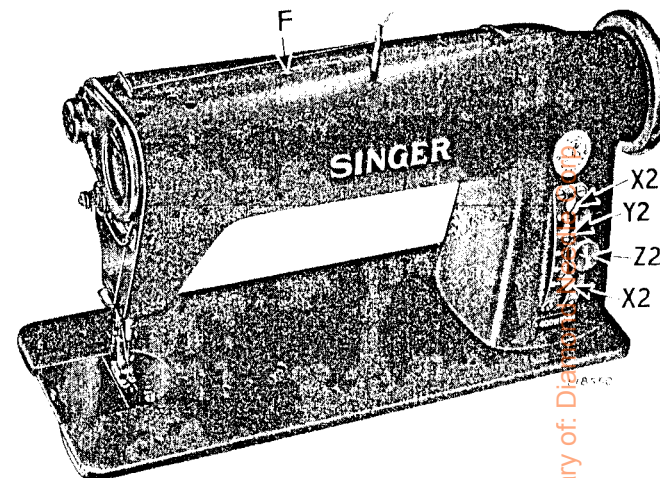
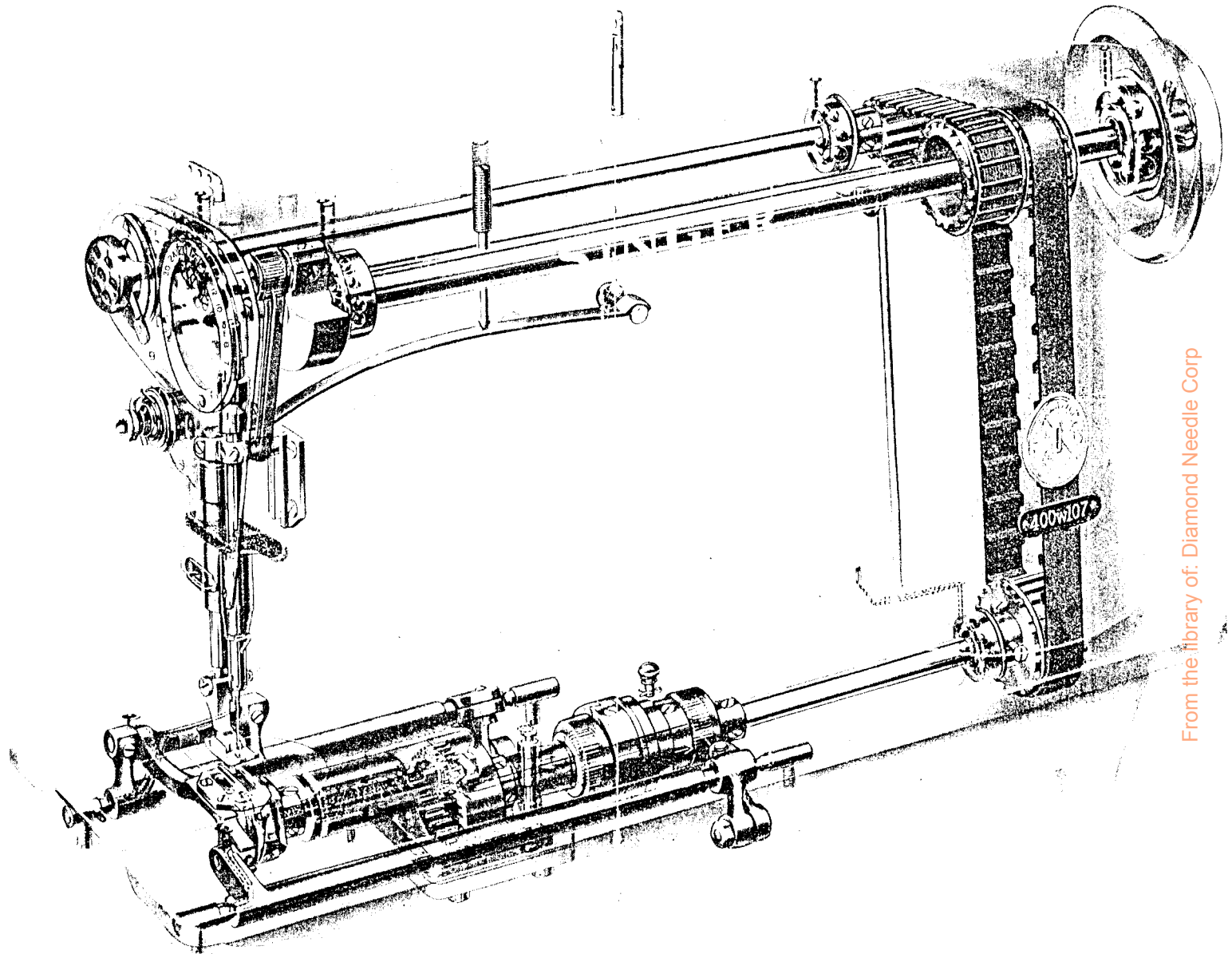

Fig. 20. Stitch Regulator and Indicator on Machine 400w106

To change the length of stitch, loosen the knurled regulating nut **Z2**, **Fig. 20** and move it up or down until the pointer **Y2** is in line with the number or mark indicating the desired length of stitch, then tighten the thumb nut. Raising the nut **Z2** lengthens the stitch. Lowering the nut **Z2** shortens the stitch. The actual number of stitches per inch produced may differ slightly depending upon sewing conditions.

The two stop screws **X2** are provided for limiting the range of adjustment obtained with regulating nut **Z2**. They may be loosened and moved to the desired positions, after which they should be securely tightened.



From the library of: Diamond Needle Corp

X-Ray View of 400w107 Machine
(Lubrication Points Shown in Red)

HINTS FOR PERFECT OPERATION

Follow instructions and oil machine regularly.

The balance wheel must always turn away from the operator.

Do not run machine with bobbin case only partly inserted.

Do not run the machine with the presser foot resting on the feed without cloth under the presser foot.

Do not run the machine when both bobbin case and needle are threaded unless there is material under the presser foot.

Do not try to help the machine by pulling the fabric lest you bend the needle. The machine feeds the work without assistance.

The slide over the bobbin case should be kept closed when the machine is in operation.

Do not press on the knee lifter lever while the machine is in operation, as this might prevent the work from feeding properly.

Occasionally remove the accumulation of lint from around the hook and from between the feed rows beneath the throat plate.

NEVER TOUCH THE STITCH REGULATOR STUD ON MACHINES 400w107, 400w108, 400w109 OR 400w110 WHEN THE MACHINE IS RUNNING.

INSTRUCTIONS FOR ADJUSTERS AND MECHANICS

TIMING THE MACHINE

The parts are in their proper timing on the various shafts when the locating screws are in the shaft splines provided for them. These locating screws are the first screws appearing when the shafts are revolved in their normal direction of rotation.

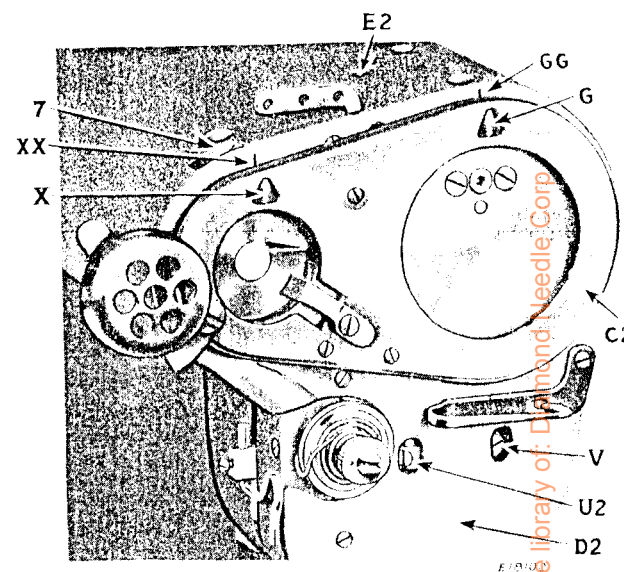

Fig. 21. Showing Timing Marks on Take-Up Discs and Face Plate

On Machines 400w107, 400w108, 400w109 and 400w110, the arm shaft, auxiliary take-up shaft and hook driving shaft with their component parts are in time with each other when the arrow G, Fig. 21 on the large take-up disc is in line with mark GG, Fig. 21 on the face plate, the arrow X, Fig. 21 on the small take-up disc is in line with mark XX on the face plate, and the arrow on the collar V1, Fig. 29 is in line with the timing mark W1, Fig. 29 on the feed lifting connection. The needle bar and hook are timed as described on page 22.

On Machine 400w106, the arm shaft, auxiliary take-up shaft and hook driving shaft with their component parts are in time with each other when the arrow G, Fig. 21 on the large take-up disc is in line with mark GG, Fig. 21 on the face plate, the arrow X, Fig. 21 on the small take-up disc is in line with mark XX on the face plate, and the timing mark V1, Fig. 29 on the feed driving eccentric flange is in line with the timing mark W1, Fig. 29 on the feed lifting connection. The needle bar and hook are timed as described on page 22.

TO ADJUST THE THREAD TAKE-UP SPRING AND PULL-OFF

On Machine 400w106, the horizontal portion of the thread pull-off, L, Fig. 22, should be set about 1/4 inch below the bottom of the holder JJ. The pull-off can be raised or lowered after loosening the set screw J.

On Machines 400w107, 400w108, 400w109 and 400w110, the horizontal part of the thread pull-off L, Fig. 22 should be set about 1/8 inch below the bottom of the holder JJ, Fig. 22. The pull-off can be raised or lowered after loosening the set screw J.

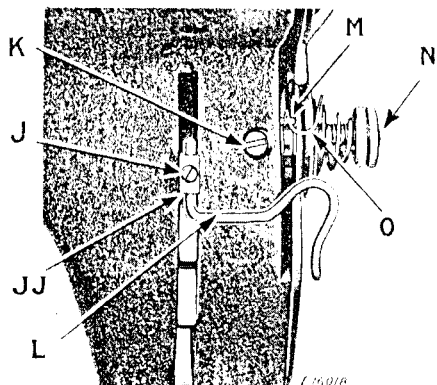

Fig. 22. Take-Up Spring Adjustments

The take-up spring should have just enough movement so that it will be through acting and will rest against the upper end of spring regulator M when the eye of the needle is about 1/16 inch above the goods on the downward stroke of the needle. After loosening the set screw K, the tension will turn with the stud N and the spring regulator may be turned to the required position.

The tension on the thread take-up spring O is regulated by turning the tension stud N to the right to increase the tension, or to the left to decrease the tension. The tension on the thread take-up spring should be just sufficient to take up the slack of the needle thread until the eye of the needle reaches the goods in its descent.

The above instructions apply to average operation. Adjustments in both setting and tension may have to be made to suit special conditions.

PRESSER BAR ADJUSTMENTS

The presser bar bushing T, Fig. 23 should be set so that its top is about $\frac{1}{32}$ inch below the top of the lifting bracket S when the bracket is all the way down.

The presser bar position guide U should be set about $\frac{1}{16}$ inch above the top of the lifting bracket S when the presser foot is down on the throat plate. The spring between the guide U and bracket S cushions the action of the lifting bracket:

To align the presser foot with the needle, have the presser down on the throat plate, hold the presser bar position guide JJ, Fig. 22 from slipping either up or down, loosen screw U2, Fig. 23, move the presser foot to the desired position and re-tighten the screw.

With the feed dog and presser foot down, there should be a slight free motion in the hand lifter lever so that the presser foot will rest on the work during operation of the machine.

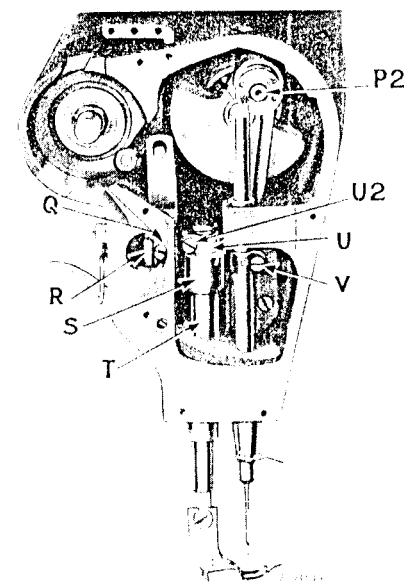

Fig. 23. Face Plate Removed

ADJUSTMENT OF THE TENSION RELEASER

The tension releaser R, Fig. 23 automatically releases the spring pressure on the tension discs when the presser bar is raised. The releaser may be moved up or down to release the tension earlier or later, by loosening the screw Q.

When stitching on heavy material the releaser should be set lower than when on light work to prevent stitching with a released tension while sewing heavy material.

TO SET THE NEEDLE BAR AT THE CORRECT HEIGHT

When the needle bar is at its highest position, the lower timing mark **B1**, Fig. 24 on the needle bar should be just visible at the lower end of the needle bar bushing **W**, Fig. 24. If the needle bar is not correctly set, loosen the screw **V**, Fig. 24 in the needle bar connecting stud and move the needle bar to the correct position.

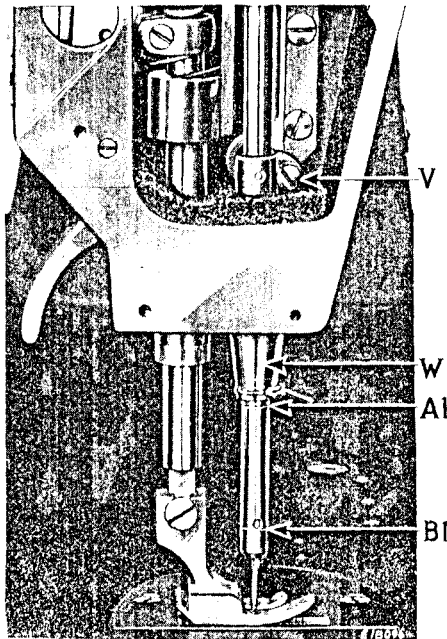

Fig. 24. Setting Needle Bar

TIMING THE SEWING HOOK

First see that the needle bar is correctly set as instructed above. Remove presser foot, slide plate, throat plate, bobbin case and feed dog.

To determine whether the hook is correctly timed, place a new needle in the machine, then **turn the top of the balance wheel over from you** until the needle bar has started to rise from its lowest position and the upper timing mark **A1**, Fig. 24 is just visible at the lower end of the needle

bar bushing **W**, Fig. 24. With the needle bar in this position, the point of the sewing hook should be at the center of the needle, as shown at **C1** in Fig. 25 and in the inset.

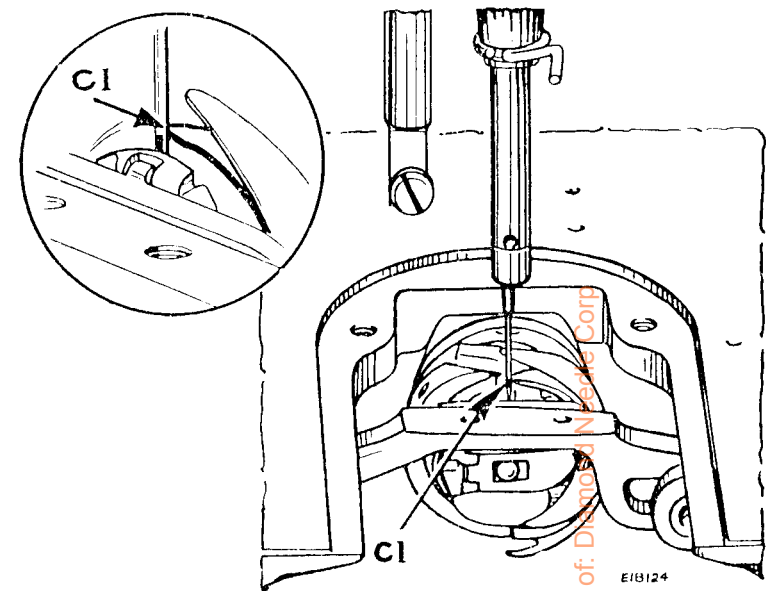

Fig. 25. Timing Sewing Hook

If the hook is not correctly timed, loosen the two screws in the hub of the hook **H1**, Fig. 26. Turn the hook on its shaft to bring the point of the hook to the center of the needle while the upper timing mark on the needle bar is centered with the bottom of the upper bushing, then tighten the two hub screws.

The point of the hook should pass the needle as closely as possible without actually touching it. The hook should be placed on the shaft as far as it will go, but if it is necessary to move the hook sidewise, loosen the set screw **J1**, Fig. 26 and move the bushing **K1**, Fig. 26 with the hook assembly as required, tapping it to the right or prying it to the left with a screwdriver against the bed casting.

If No. 16 needles or larger are used, it may be necessary, when replacing a Bobbin Case Holder or Hook and Bobbin Case Complete, to provide additional clearance for the needle by stringing the needle guard portion of the Bobbin Case Holder. Unless this is done, the needle guard may pinch the needle thread, causing thread breakage, or it may deflect the needle, causing skipping and damage to the needle.

TO REMOVE AND REPLACE THE SEWING HOOK

Remove the needle, slide plate and bobbin case. Take out the screw **F1**, Fig. 26 and remove the bobbin case holder position bracket **G1**. Loosen the two set screws at **H1** in the hub of the hook, then turn the balance wheel over from you until the feed bar **AA**, Fig. 27 is raised to its highest point. Turn the sewing hook until the thread guard **DD** is at the bottom, as shown in Fig. 27, and turn the bobbin case holder **BB** until it is in the position shown in Fig. 27. The sewing hook can then be removed from the hook shaft.

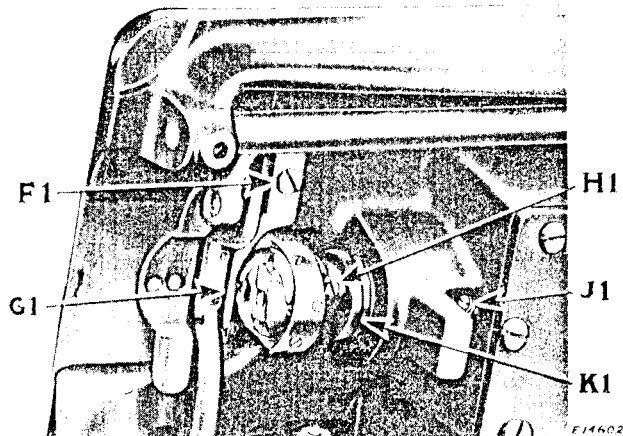

Fig. 26. Removing Hook

When placing a new sewing hook on the shaft, have the thread guard **DD** of the hook at the bottom and the bobbin case holder **BB** turned to the position shown in Fig. 27, so that the hook will clear the feed bar **AA**.

When the hook is in position on the shaft, turn the bobbin case holder **BB** until the notch **CC** is at the top, then replace the bobbin case holder position bracket, being careful to see that the position stud **G1**, Fig. 26 enters the notch at the top of the bobbin case holder, as shown in Fig. 26,

then securely fasten the position bracket by means of the screw **F1**. Replace the needle and time the sewing hook as instructed on pages 22 and 23. Replace the bobbin case and slide plate.

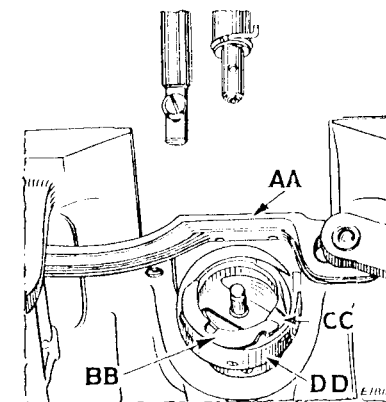

Fig. 27. Showing Correct Position of Thread Guard (**DD**) and Bobbin Case Holder (**BB**) for Removal of Sewing Hook

TO REMOVE THE SEWING HOOK SHAFT

Remove the sewing hook as instructed above. Loosen the pinch screw in the feed lifting rock shaft crank **N1**, Fig. 29 and drop the feed bar **AA**, Fig. 27 down out of the way. Loosen the bushing set screw **J1**, Fig. 26 and withdraw the bushing and hook shaft assembly as shown in Fig. 28. Take out the two screws **H2** and remove the end bearing **G2**, then withdraw the shaft and gear.

When assembling the hook shaft bushing, see that the thrust washer on the hook shaft has its small end toward the gear. The end bearing **G2**, Fig. 28 can be moved endwise enough to control the end play of the hook shaft before tightening the two screws **H2**, Fig. 28. When replacing this unit in the machine, be sure that the set screw enters the spline in the bottom of the bushing. See page 27 when resetting the feed lifting rock shaft.

TO ADJUST ROTATING HOOK SHAFT BUSHING (Pressure Lubricating Type)

The hook shaft bushing contains a regulating screw **V2**, Fig. 28 for controlling the oil supplied to the sewing hook raceway. Turning in the screw **V2** increases the amount of oil supplied to the hook; backing this screw out decreases the amount supplied. Normal adjustment is accom-

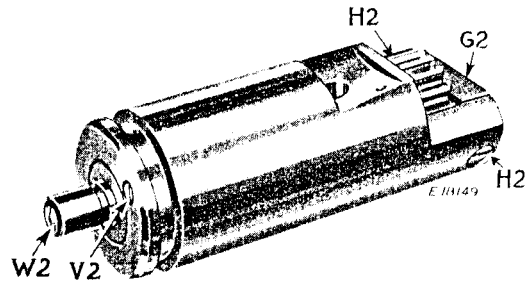

Fig. 28. Adjustment of Oil Flow Regulator
in Hook Shaft Bushing

plished by turning this screw in all the way, then backing it out again about 2-1/2 turns. Less than 2-1/2 turns may be required if continuous runs are being made or material with considerable sizing is being stitched.

The oil wick complete No. 270176, **W2**, Fig. 28 carried by the hook shaft, at the sewing hook end, should be replaced occasionally as it may become clogged by lint and dirt from the oil.

If an excess of oil is being delivered to the hook and cannot be controlled by the metering screw **V2**, Fig. 28, check to be sure that the oil wick has not become detached from the filter screw **W2**, Fig. 28 and that the filter screw is securely tightened. Inspect all oil passages in the shaft and bushing to see that they have not become clogged with lint or dirt. If oil wick is too loose, too much oil will flow to the hook raceway.

TO REMOVE AND REPLACE THE HOOK DRIVING SHAFT (Except Machine 400w106)

Slip the belt off the lower pulley **Y1**, Fig. 29, then loosen the two set screws **X1**, Fig. 29 and remove the pulley from the shaft. Loosen the four set screws **U1** and **P1**, Fig. 29 in the feed and feed lifting eccentrics, and the two set screws at **R1**, Fig. 29 in the internal gear. Do not loosen the screw in the collar **V1**, Fig. 29. Withdraw the shaft with ball bearing from the pulley end.

When replacing the shaft, push it in, being sure the feed eccentrics are on the shaft in their proper order, until the snap ring on the ball bearing seats on the casting, then tighten the gear screws **R1**. Before tightening the screws **U1**, the feed eccentric should be pushed to the left as far as it will go.

Tighten the screws **U1**, Fig. 29, having the first screw (as the shaft is turned away from you) enter the groove in the shaft. Then move the feed lifting eccentric to the left as far as it will go and tighten the screws **P1**, with the first or upper set screw in the groove in the shaft. Replace pulley **Y1** and belt. Then retune the shaft as instructed on page 19.

If it is found necessary to replace the ball bearing on the hook driving shaft, or to reset or replace the hook driving shaft bushing, note that the ball bearing is correctly positioned when the pulley **Y1**, Fig. 29 is flush with the ball bearing on one side and its hub is flush with the end of the shaft on the other. With the ball bearing in this position, place the shaft

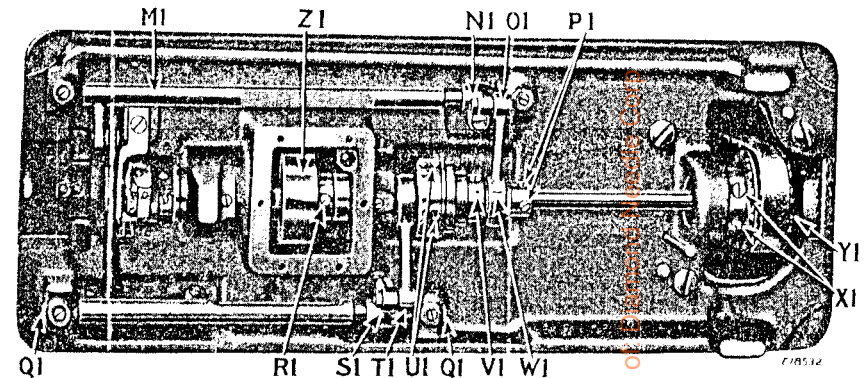

Fig. 29. Underside of Machine 400w107

in the machine and assemble the internal gear **Z1**, Fig. 29 with its inner face flush with the end of the shaft. The hook driving shaft bushing will be correctly positioned when end play has been removed from the shaft by setting the bushing against the hub of the internal gear.

If the feed rock shafts have been disturbed, the small ends of the connections **O1** and **T1**, Fig. 29 should be disconnected while setting the eccentrics, and enough side play left for the connections so that their free ends can be moved sidewise about 1/32 to 1/16 inch. See paragraph on feed mechanism before assembling the rock shaft connections.

TO REMOVE AND REPLACE THE HOOK DRIVING SHAFT (Machine 400w106)

Slip the belt off the lower pulley **Y1**, Fig. 30, then loosen the two set screws **X1**, Fig. 30 and remove the pulley from the shaft. Loosen the four set screws **U1** and **P1**, Fig. 30 in the feed driving and feed lifting eccentrics, and the two set screws at **R1**, Fig. 30 in the internal gear. Withdraw the shaft with ball bearing from the pulley end.

When replacing the shaft, push it in, being sure the feed eccentrics are on the shaft in their proper order, until the snap ring on the ball bearing seats on the casting, then tighten gear screws R1. Before tightening the screws U1, the feed driving eccentric should be pushed to the left as far as it will go.

Tighten the screws U1, Fig. 30, having the first screw (as the shaft is turned away from you) enter the groove in the shaft. Then move the feed lifting eccentric to the left as far as it will go and tighten the screws P1, with the first or upper set screw in the groove in the shaft. Replace pulley Y1 and belt. Then retime the shaft as instructed on page 19.

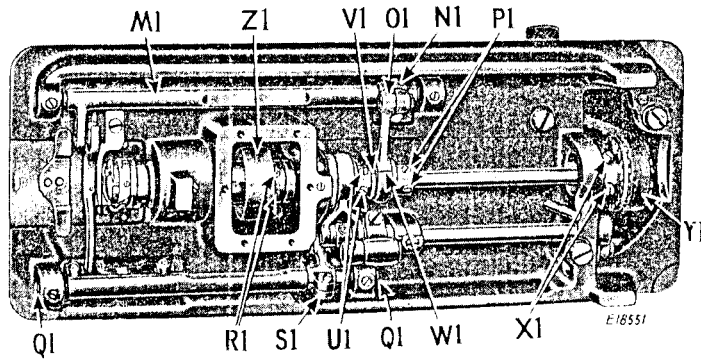

Fig. 30. Underside of Machine 400w106

If it is found necessary to replace the ball bearing on the hook driving shaft, or to replace the hook driving shaft bushing, note that the ball bearing is correctly positioned when the pulley Y1, Fig. 30 is flush with the ball bearing on one side and its hub is flush with the end of the shaft on the other. The hook driving shaft bushing should be set with its flange tight against the casting. Place the shaft in the machine and assemble the internal gear Z1, Fig. 30 with its hub also against the bushing, thus removing all end play from the shaft.

FEED MECHANISM

If a faster or slower feed timing than the standard setting is desired see page 19, loosen the pulley screws X1, Fig. 29 and turn the shaft as desired, then tighten the screws. The hook must then be retimed as instructed on pages 22 and 23.

The feed dog is lined up with the slots in the throat plate by moving the bearing centers at Q1, Fig. 29 to right or left. It may be centered lengthwise so it will not strike the ends of the slots when making the longest stitch, by loosening the clamp screw in the feed rock shaft crank S1, Fig. 29.

On Machines 400w107, 400w108, 400w109 and 400w110, after removing the feed driving or feed lifting rock shafts, the cranks S1 or N1, Fig. 29 should be adjusted to right or left until they line up perfectly with the free ends of the connections when the latter are exactly midway between their two extreme side play positions. The cone bearings O1 and T1, Fig. 29 should then be adjusted by first turning the cone screws down tight and then backing them off one quarter of a turn, locking them in position with the lock nut. This gives a perceptible amount of play in the connection which is necessary for all clearance.

On Machine 400w106, after removing the feed driving or feed lifting rock shafts, the cranks S1 or N1, Fig. 30 should be adjusted to right or left to maintain proper alignment of the driving connections. The cone bearing O1, Fig. 30 should then be adjusted by first turning the cone screw down tight and then backing it off one quarter of a turn, locking it in position with the lock nut. This gives a perceptible amount of play in the connection which is necessary for all clearance.

SETTING THE FEED DOG AT THE CORRECT HEIGHT

The feed dog may be raised or lowered by loosening the pinch screw in the feed lifting crank N1, Fig. 29. The feed dog is usually set so that it shows a full tooth above the throat plate when at its highest position. See that there is no lint packed between the feed dog and throat plate.

ADJUSTING THE FEED ECCENTRIC (Except Machine 400w106)

The feed eccentric is provided with a gib L2, Fig. 31 which can be adjusted to take up any loose motion between the feed eccentric and the eccentric body. To adjust the gib, loosen the two locking screws K2 nearest the gib, then turn in the two adjusting screws J2 against the gib until all play is eliminated and the eccentric fits snugly in the slot in the eccentric body. Securely tighten the two locking screws K2. By tightening the adjusting screws J2 firmly, the eccentric will be locked so that the stitch length cannot be changed by unauthorized persons.

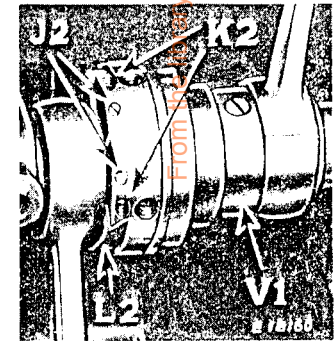

Fig. 31. Feed Eccentric

A spring held by the collar V1 presses against the feed eccentric cam to prevent it from moving out of position while the machine is operating. The collar V1 should ordinarily be set flush with the end of the hub of the eccentric body. The set screw in this collar must enter the timing groove in the eccentric body.

ADJUSTING FEED DRIVING MECHANISM (Machine 400w106)

The forward and backward motion of the feed dog is derived from feed driving eccentric **G3**, Fig. 32, which is located on the hook driving shaft and is positioned as described on page 25. The linkage driven by eccentric **G3**, which drives the crank **S1**, Fig. 32, is supported by rock shaft **B3**, Fig. 32. This rock shaft is rotated a slight amount by the linkage in the upright part of the arm through connection to the adjusting nut **Z2**, Fig. 20. The rock shaft **B3** turns within split bushing **A3**, Fig. 32. After loosening lock nut **C3**, Fig. 32, adjusting screw **D3**, Fig. 32 should be tightened sufficiently to prevent regulating nut **Z2**, Fig. 20 from moving vertically in the slot of the stitch indicator when this nut is loose and the machine is in operation. When adjustment has been made, firmly tighten lock nut **C3**.

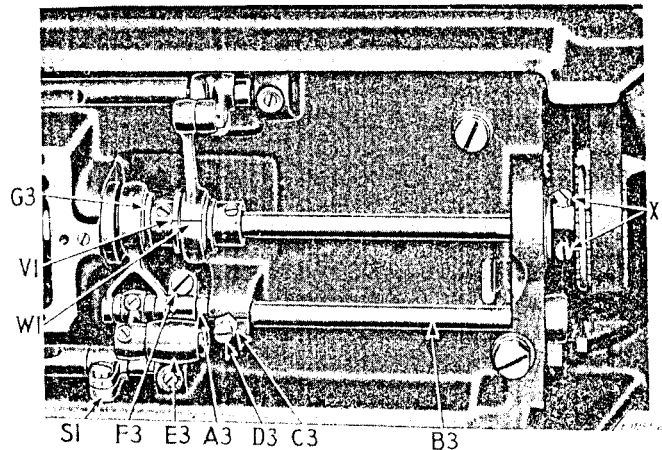

Fig. 32. Adjustments on Feed Driving Mechanism of Machine 400w106

The position in which the crank arm **E3**, Fig. 32 is secured to the rock shaft **B3** affects the actual travel of the feed dog with respect to the setting of the regulating nut **Z2**, Fig. 20. The proper position can best be obtained by actual trial. To do this, set the pointer **Y2**, Fig. 20 for 7 stitches per inch, loosen the screw **F3** and try various positions of crank arm **E3**, Fig. 32, taking care at each trial to securely tighten screw **F3** before operating the machine. When properly set, the feed driving linkage will be approximately as shown in Fig. 32, and will actually produce the desired 7 stitches per inch. With the timing thus set, other positions of the pointer **Z2**, Fig. 20 will produce the approximate number of stitches indicated by the figures on the graduated scale.

TO REPLACE THE ARM SHAFT CONNECTION BELT (Except Machine 400w106)

Remove the needle to avoid damaging it while the arm and hook shafts are out of time. Work the belt off the lower pulley **Y1**, Fig. 29.

Loosen the two screws in the pulley groove and remove the balance wheel and the ball bearing which comes out with the wheel. Lift the belt up and draw it out around the arm shaft through the space normally occupied by the ball bearing.

Replace the belt through the ball bearing hole. After placing the belt over the upper pulley **M2**, Fig. 33, replace the balance wheel. To remove all end play from the shaft, lightly tighten the set screws in the balance wheel and, holding the needle bar crank in place, tap the balance wheel into position with the palm of the hand; then tighten screws firmly. Turn the arm shaft until the arrow **G**, Fig. 21 on the take-up disc is in line with its timing mark **GG**, Fig. 21, and turn the lower pulley until the timing mark on the collar **V1**, Fig. 29 is opposite the mark **W1**, Fig. 29, being careful to see that the two set screws **X1**, Fig. 29 are accessible. With the two shafts in this position, lead the belt onto the lower pulley at the point farthest from you and then, while turning the balance wheel over from you, slide the belt over the rest of the width of the lower pulley. Check the timing of the machine before starting to sew, see page 19, and if necessary, loosen the set screws in the lower pulley to bring the upper and lower shafts into exact time.

TO REPLACE THE ARM SHAFT CONNECTION BELT (Machine 400w106)

Remove the needle to avoid damaging it while the arm and hook shafts are out of time. Work the belt off the lower pulley **Y1**, Fig. 30.

Loosen the two screws in the pulley groove and remove the balance wheel and the ball bearing which comes out with the wheel. Lift the belt up and draw it out around the arm shaft through the space normally occupied by the ball bearing.

Replace the belt through the ball bearing hole. After placing the belt over the upper pulley **M2**, Fig. 33, replace the balance wheel. To remove all end play from the shaft, lightly tighten the set screws in the balance wheel, and holding the needle bar crank in place, tap the balance wheel into position with the palm of the hand; then tighten screws firmly. Turn the arm shaft until the arrow **G**, Fig. 21 on the take-up disc is in line with its timing mark **GG**, Fig. 21 and turn the lower pulley until the timing mark **V1**, Fig. 32 is opposite the mark **W1**, Fig. 32, being careful to see that the two set screws **X1**, Fig. 32 are accessible. With the two shafts in this position, lead the belt onto the lower pulley at the point farthest from you and then, while turning the balance wheel over from you, slide the belt over the rest of the width of the lower pulley. Check the timing of the machine before starting to sew, see page 19, and if necessary, loosen the set screws in the lower pulley to bring the upper and lower shafts into exact time.

TO REMOVE AND REPLACE THE SMALL TAKE-UP SHAFT CONNECTION BELT

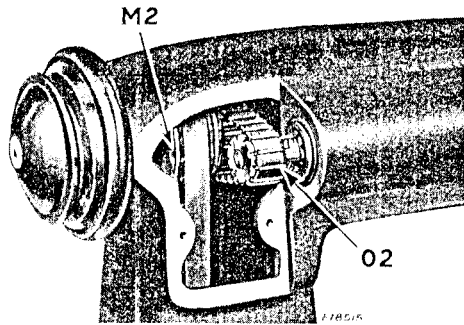

Fig. 33. Rear Arm Cover Removed

Remove the arm shaft connection belt as instructed above, then slip the take-up belt **O2**, Fig. 33 off the pulleys, being careful not to place too much sidewise strain on the arm shaft while it is unsupported by the rear bearings. When replacing the belt, have the arrows **G** and **X** on both take-up discs in line with their respective timing marks **GG** and **XX** as shown in Fig. 21. Replace the small belt **O2**, Fig. 33 on both pulleys, then replace the long belt as instructed above.

TO REMOVE AND REPLACE THE SMALL TAKE-UP SHAFT

The small take-up shaft must be removed from the balance wheel end of the machine. Remove the take-up belt **O2**, Fig. 33 as instructed on page 29. Remove the take-up guard **C2**, Fig. 21 and loosen the set screw, through the hole **7**, Fig. 21 in the top of the arm, which holds the small take-up disc. Remove the shaft with the rear ball bearing and the pulley intact.

The front and rear ball bearings for replacement on the small take-up shaft will be a tight fit. The front ball bearings should be placed on the shaft before it is assembled in the machine. To get the correct position, force it on the shaft until flush with the hub of the small rotary take-up and after placing the shaft in the machine with the snap ring of the front ball bearing against its seat, force the rear ball bearing on until all end play has been eliminated.

When replacing the belt **O2**, make certain that the set screws in the small pulley are accessible when the take-up discs are at their timing positions.

TO REMOVE THE ARM SHAFT

The arm shaft must be removed from the face plate end of the machine and under no circumstances should an attempt be made to separate the needle bar crank from the shaft, as they are manufactured as a unit for accuracy. Remove face plate and associated parts. Remove the needle set screw. Loosen the needle bar pinch screw **V**, Fig. 23, remove the needle bar through the top of the arm, and remove the needle bar connecting stud. Remove the needle bar crank stud **P2**, Fig. 23 by loosening the two set screws, reached through hole **E2**, Fig. 21 in the top of the arm. To remove the needle bar connecting link, drop it to its lowest position, draw forward out of the guide block, turn at right angles, then draw upward and outward. (If for any reason the needle bar guide block is disturbed, it must be aligned properly when assembling the machine). Remove the belts as instructed in the preceding paragraphs, loosen the spot screw and set screw in pulley **M2**, Fig. 33 and withdraw the arm shaft and crank from the needle bar end. If it is found necessary to replace the ball bearing, it should be forced onto the shaft until the slip ring side is flush with the needle bar crank.

INSTRUCTIONS ON BALL BEARINGS AND NEEDLE BEARINGS

There are five ball bearings and three needle bearings in this machine that will give long, trouble-free life with reasonable care. Oiling instructions given on page 4 should be followed carefully. Care should be taken to see that no foreign matter gets into these bearings when handling them out of the machine.

The ball bearings on the forward end of the arm shaft, the rear end of the small take-up driving shaft, and the rear end of the hook driving shaft are forced on into their correct position at the factory and should not be removed except for replacement. When replacing them, make certain that the shielded side is always out and that they are a tight fit on their respective shafts.

The ball bearing on the balance wheel is also a forced fit. Tools for removing the balance wheel from the machine and for removing this bearing can be procured from the SINGER Agencies if needed.

The three needle bearings should receive the same care as the ball bearings and should not be removed from their respective housings except for replacement. They should be replaced by pressing on the numbered end of the outside shell as any pressure on the unnumbered end of the shell will distort them and cramp the bearings. After this, care should be taken to see that the needle bearings roll freely in their respective housings.